

# BANAK

# TAND

AR-0041

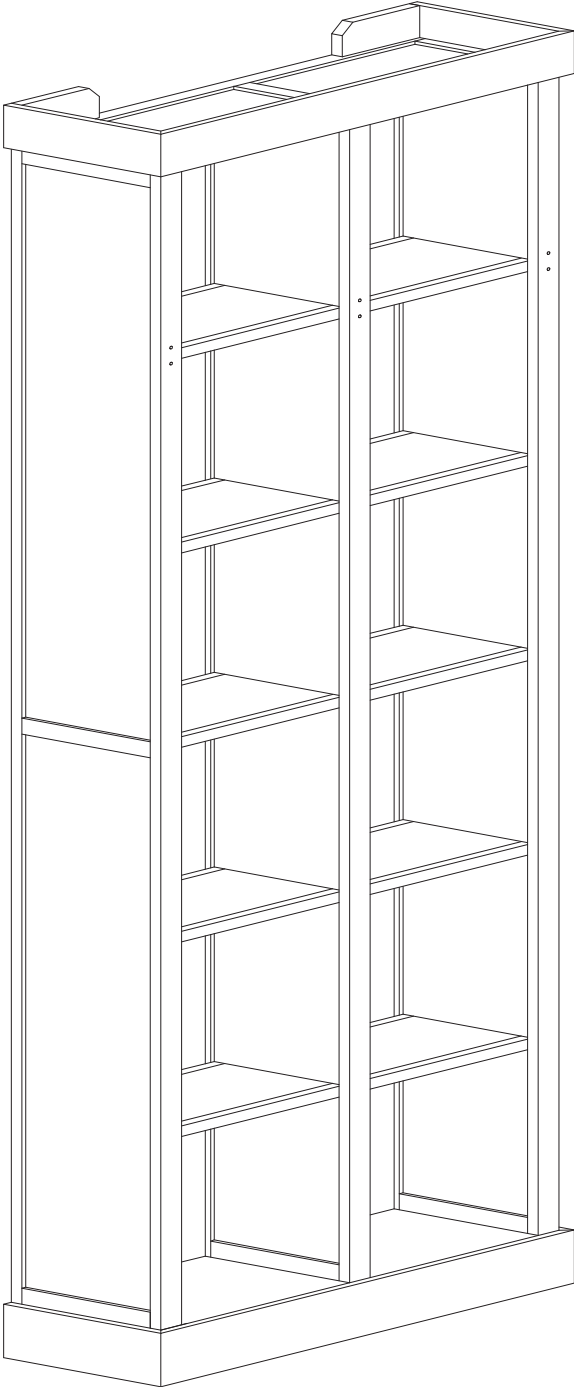

# BANAK

# TAND

AR-0041

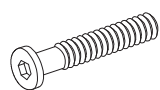
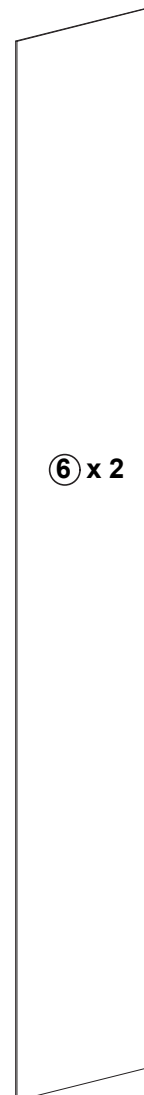
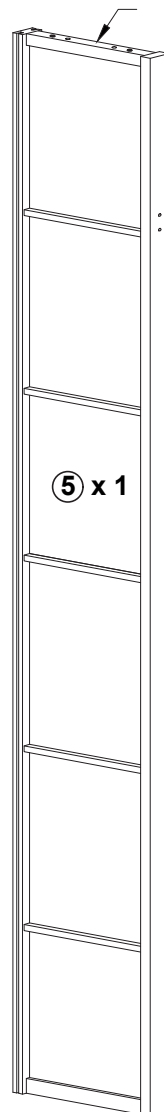
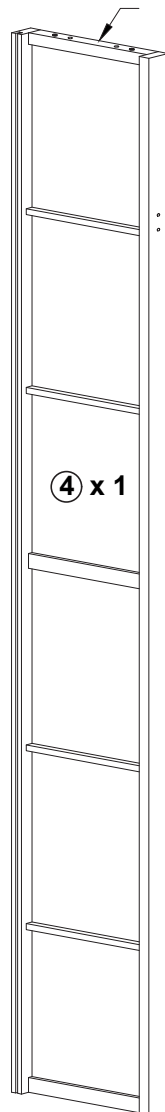
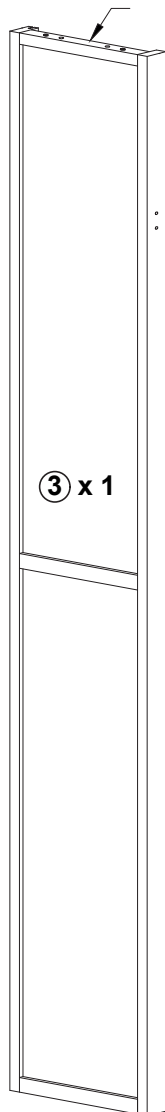
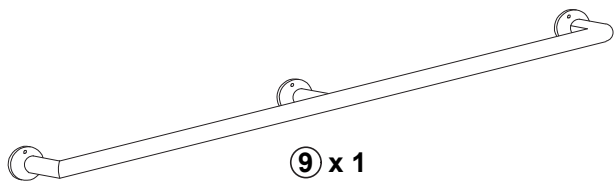
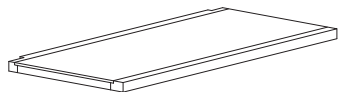
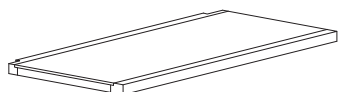
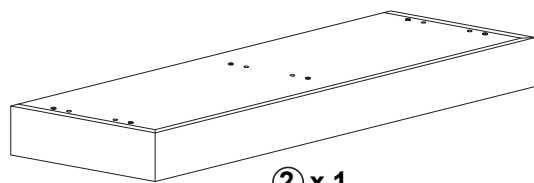
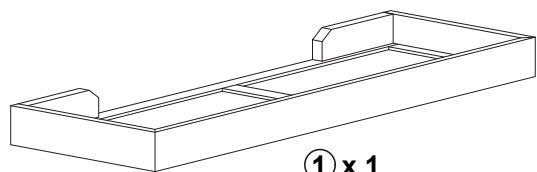

Ⓐ x 12  
( M6x30 )

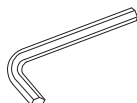

Ⓑ x 1

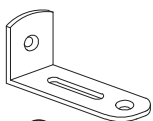

Ⓒ x 2



Ⓓ x 13  
( 4x20 )

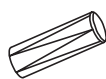

Ⓔ x 12  
( 8x30 )



Ⓕ x 4  
( 3.5x15 )

# BANAK

# TAND

AR-0041

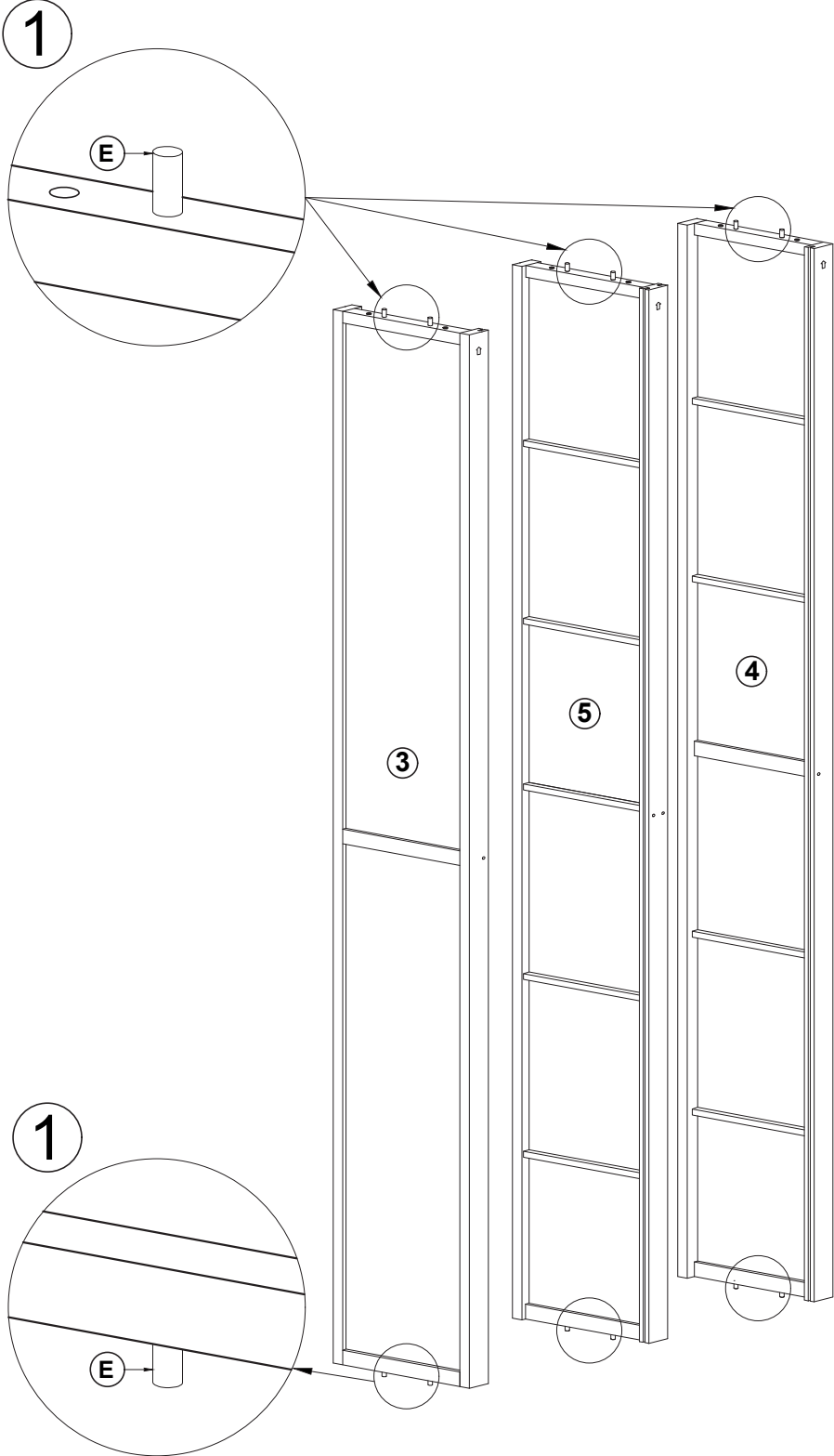

# BANAK

# TAND

AR-0041

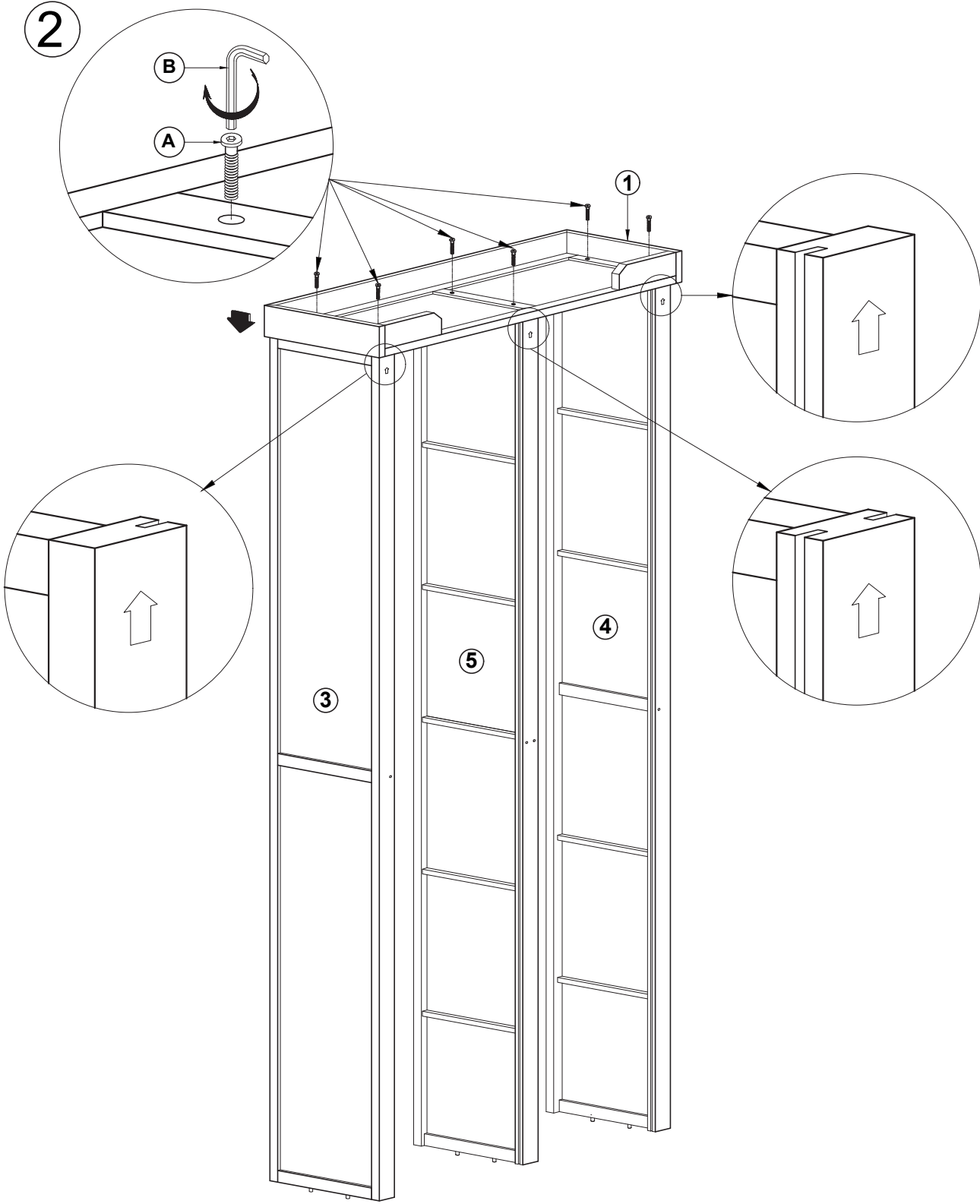

# BANAK

# TAND

AR-0041

3

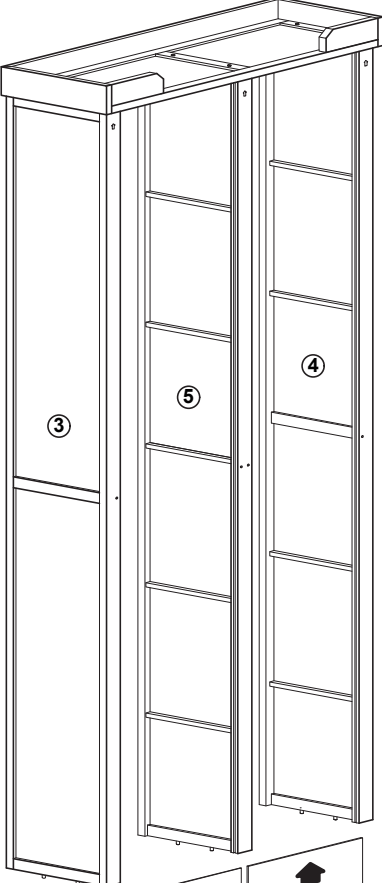

4

5

3

6

6

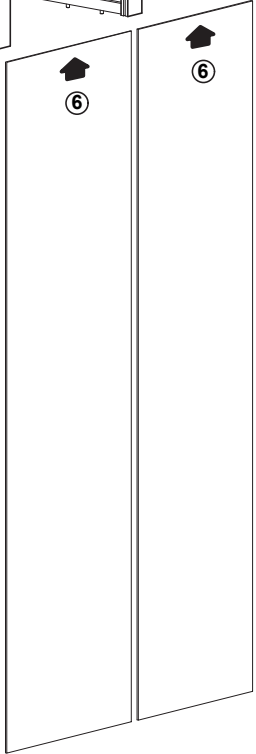

# BANAK

# TAND

AR-0041

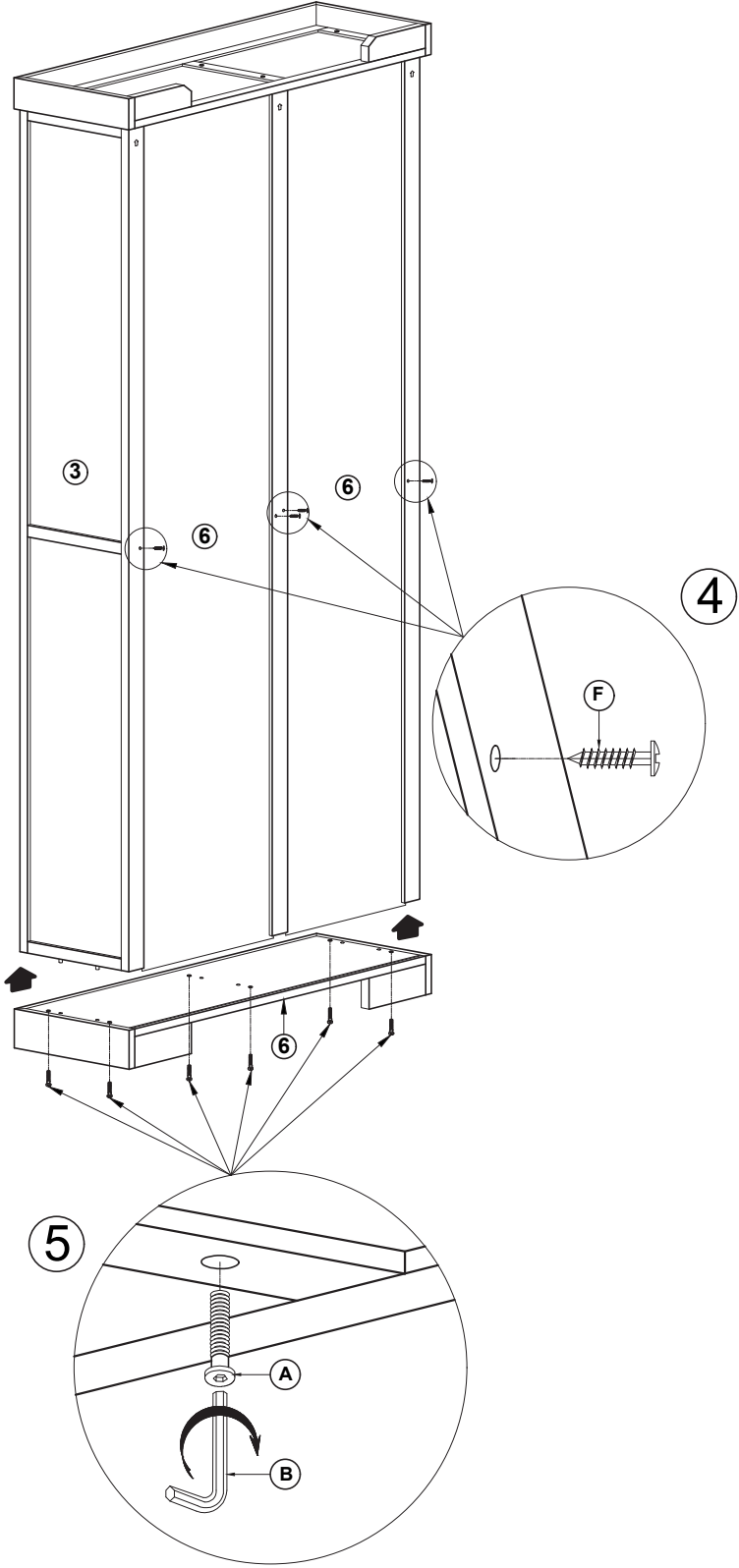

# BANAK

# TAND

AR-0041

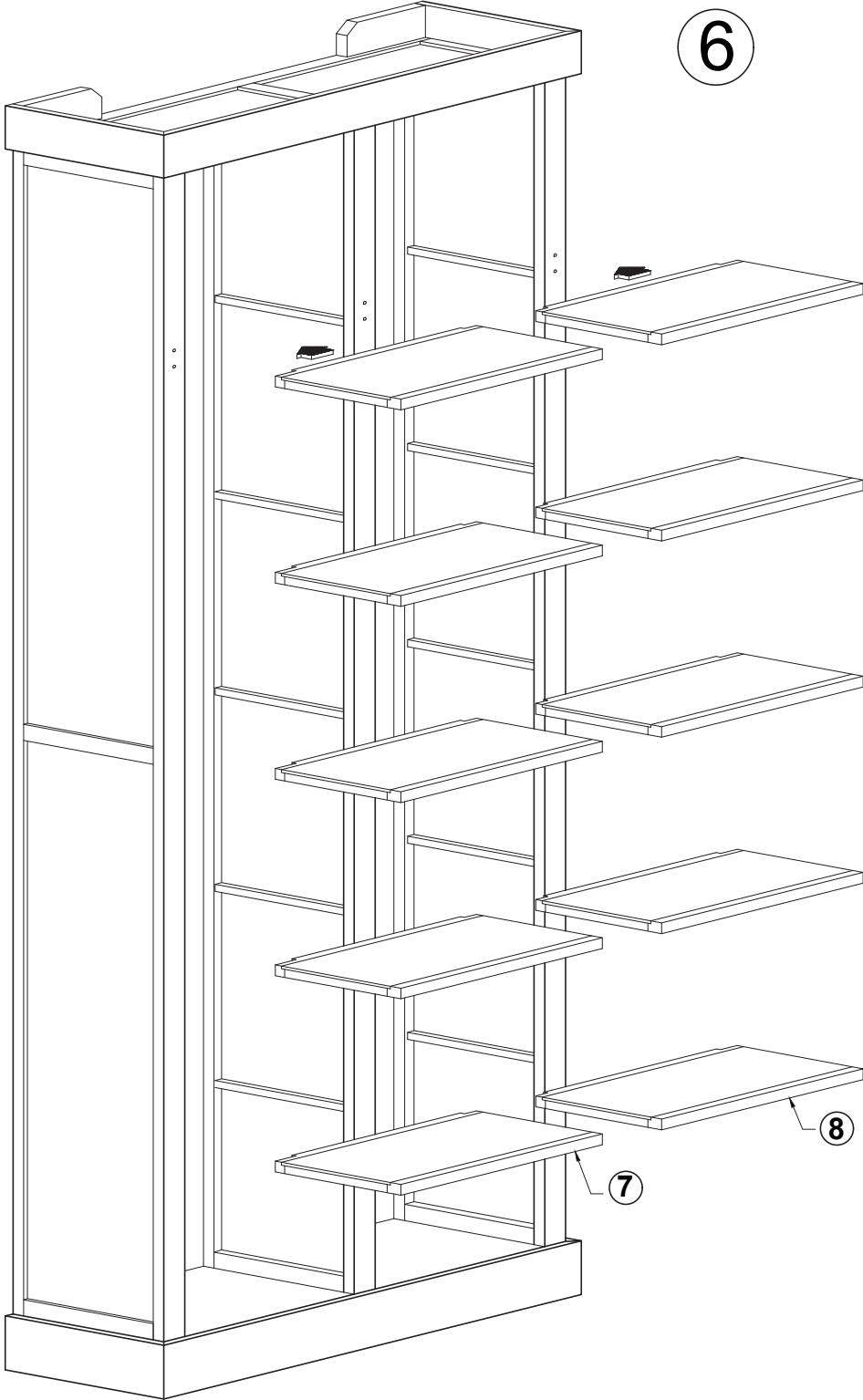

# BANAK

# TAND

AR-0041

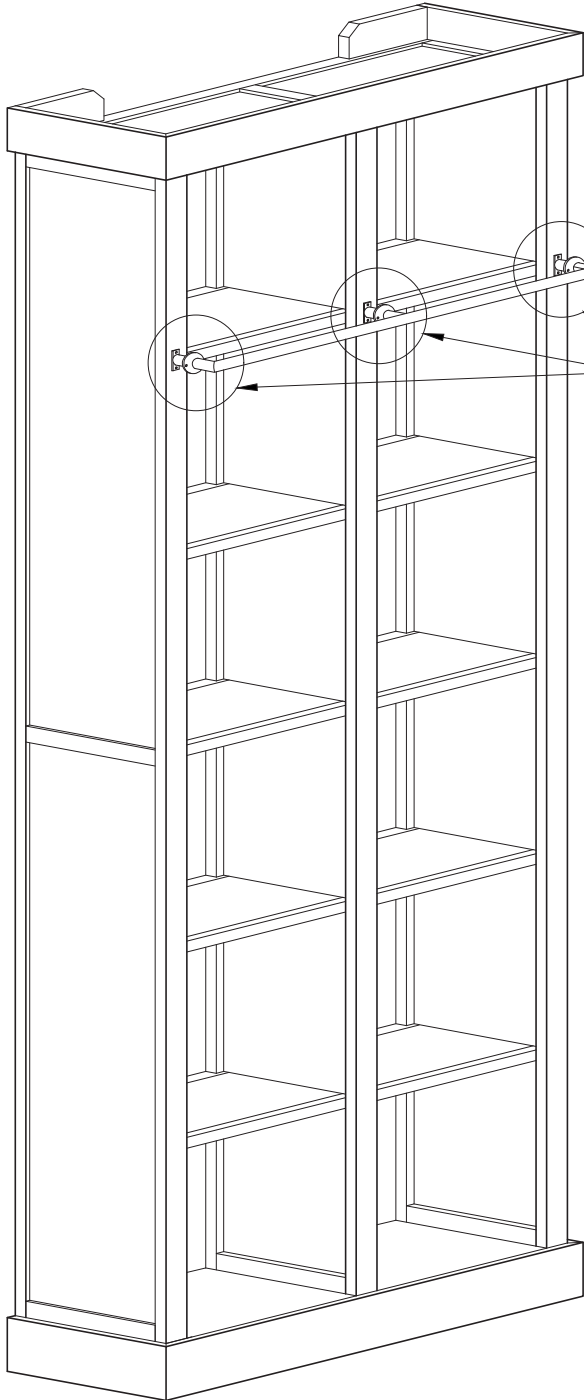

7

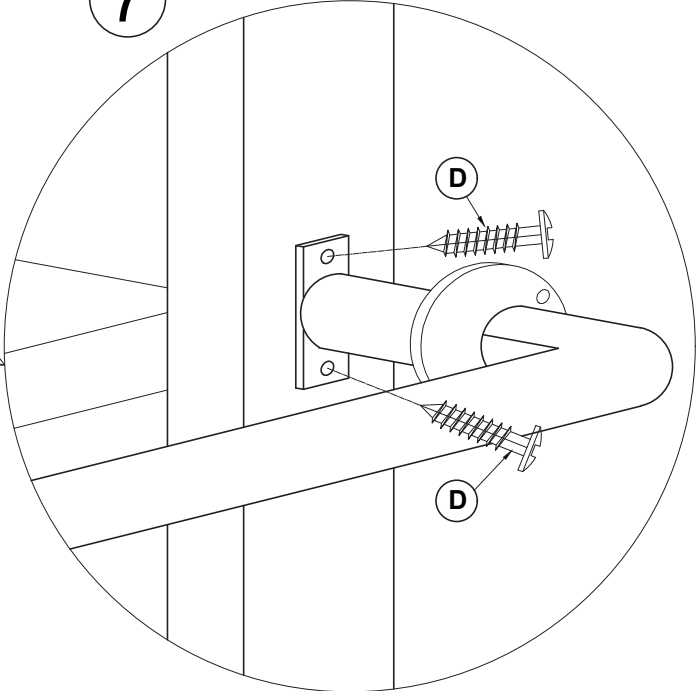

8

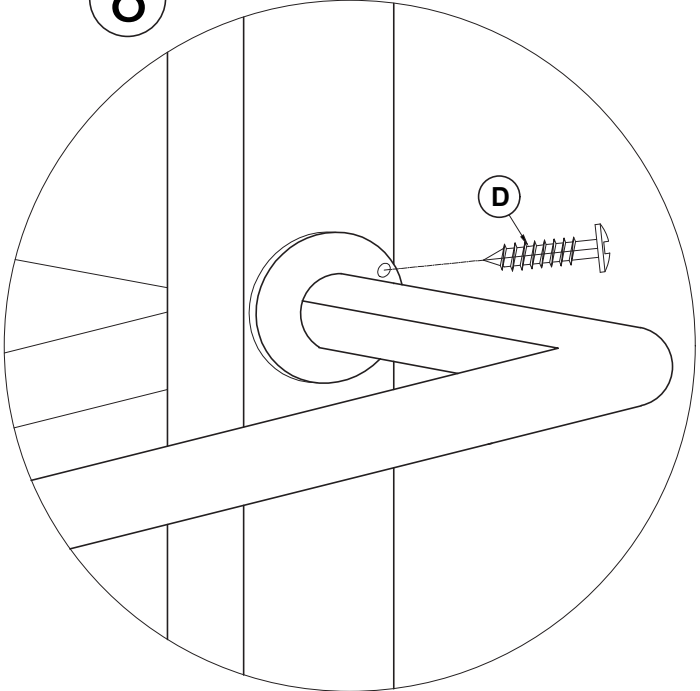



# BANAK

# TAND

AR-0041

